

ECOPHON AKUSTO™ WALL C EXTRA BASS

Ecophon Akusto™ Wall C Extra Bass has a concealed grid and bevelled edge to create a narrow groove between each panel. Available in a variety of surface options. The wall absorber has excellent sound absorption qualities from low to high sound frequencies. Best room acoustic properties are achieved when used together with a sound absorbing ceiling.



Ecophon Akusto™ Wall C Extra Bass

SYSTEM RANGE



Size, mm	2700x600
Akusto Extra Bass (40mm)	•
Thickness	40
Inst. Diagr.	M535, M547



Akusto Wall C Extra Bass system

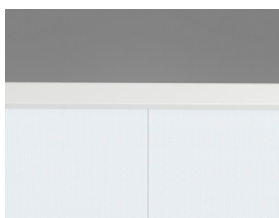

Akusto Wall C Extra Bass system from above



Akusto Wall C

TYPE OF APPLICATION

- Office
- Education
- Healthcare
- Additional areas



ACOUSTIC

Sound Absorption

Test results according to EN ISO 354. Classification according to EN ISO 11654, and the single value ratings for Noise Reduction Coefficient, NRC and Sound Absorption Average, SAA according to ASTM C 423.

α_p , Practical sound absorption coefficient

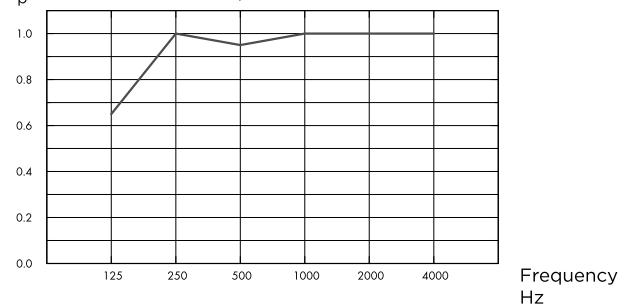

— Akusto Wall C Extra Bass 80 mm, 80 mm o.d.s.
o.d.s = overall depth of system

	THK mm	o.d.s. mm	α_p , Practical sound absorption coefficient						α_w	Sound absorption class
			125 Hz	250 Hz	500 Hz	1000 Hz	2000 Hz	4000 Hz		
Extra Bass	80	80	0.65	1.00	0.95	1.00	1.00	1.00	1.00	A

	THK mm	o.d.s. mm	NRC	SAA
Extra Bass	80	80	1.00	1.00



INDOOR AIR QUALITY

Certificate / Label	
Eurofins Indoor Air Comfort®	IAC Gold
French VOC	A+





CARBON FOOTPRINT

Life-cycle stages A1 to C4 from EPD, in conformity with ISO 14025 / EN 15804

	kg CO ₂ equiv/m ²
Akusto Wall C Extra Bass/Texona	7,42
Akusto Wall C Extra Bass/Akutex FT	7,26
Akusto Wall C Extra Bass/Super G	8,74



CIRCULARITY

Minimum post-consumer recycled content	60%
Recyclability	Fully recyclable



FIRE SAFETY

The glass wool core of the tiles is tested and classified as non-combustible according to EN ISO 1182.

Country	Fire standard	Class
Europe	EN 13501-1	A2-s1,d0



HUMIDITY RESISTANCE

Class C, relative humidity 95% and 30°C, according to EN 13964:2014



VISUAL APPEARANCE

Akusto Wall in white has high light reflectance. Light reflectance and nearest NCS colour sample for all the different colours: See Ecophon Colours and surfaces.



CLEANABILITY

Daily dusting, vacuum cleaning and weekly wet wiping (Akutex FT surface). Weekly dusting and vacuum cleaning (Texona) as required.



ACCESSIBILITY

The tiles are non-demountable.



INSTALLATION

Installed according to installation diagrams, installation guides and drawing aid.



SYSTEM WEIGHT

Weight information is indicative and subject to variation.

	kg/m ²
Akusto Wall C/Akutex FT	3,5
Akusto Wall C/Texona	3,5
Akusto Extra Bass	1,2



MECHANICAL PROPERTIES

No additional live load is allowed.



CE

Ecophon ceiling systems are CE marked according to the European harmonized standard EN13964:2014. CE marked construction products are covered by a Declaration of Performance (DOP) which enables customers and users to easily compare performance of products available on the European market.

COLOURS AND DESIGN

Super G

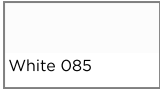

White O85

Akutex™ FT

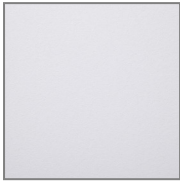

White frost



Deep Sea

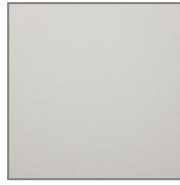

Sage mist

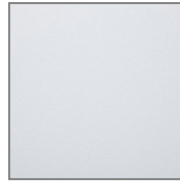

Morning rain

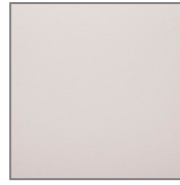

Scallop shells



Spring Leaf



Pine Green



Wet sand



Silent steam

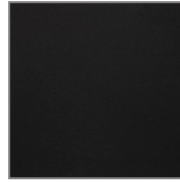

Dark diamond

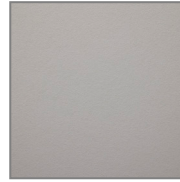

Cloudy day



Volcanic ash



Silver stone

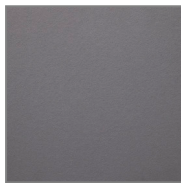

Silk slate

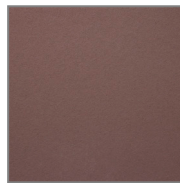

Dark Chestnut



Basalt Rock

Texona

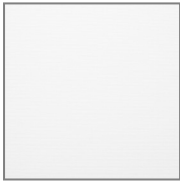

Winter White



Stone Grey



Silver Lining

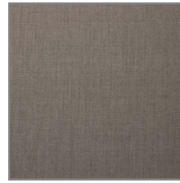

Thunder Grey

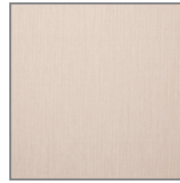

Oat Beige

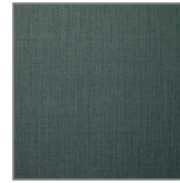

Deep Forest



Linden Green



Midnight Sky



Ice Blue



Autumn Berry



Heathland Rose



Cloudy Pink

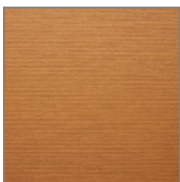

Golden Sand

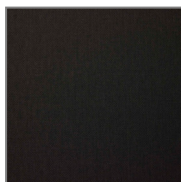

Shadow Black

Connect Shadow + Vertical

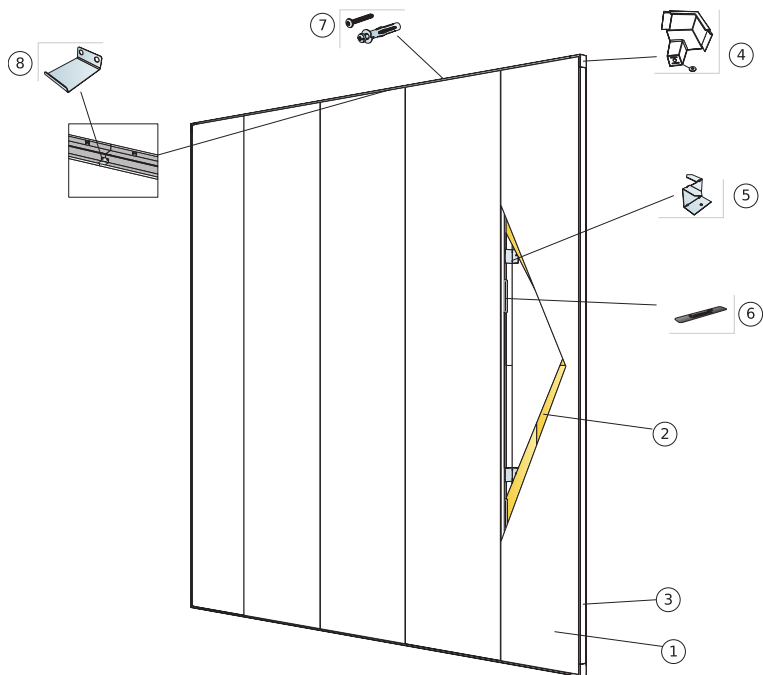

© Ecophon Group

Installation diagram (M535) for Ecophon Akusto Wall C Extra Bass vertical installation with Connect shadow profiles.

Quantity specification (excl. wastage)

	Size, mm
	2700x600
1 Akusto Wall C	0,62/m ²
2 Akusto Extra Bass	1,25/m ²
3 Connect Shadow Profile	as required
4 Connect Shadow Corner (Incl. washer for leveling)	as required
5 Connect Ambit fixing installed at 1000 mm centres	as required
6 Connect Spline	as required
7 Installation screw, installed at 200 mm centres (select fastener according to wall material)	as required
8 Connect Shadow Splice. Used to extend profiles where needed.	as required

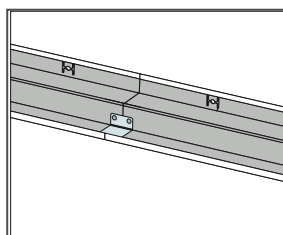
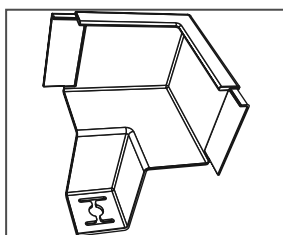
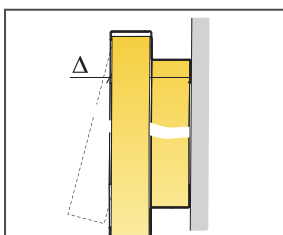

Size, mm	Max live load (N)	Min load bearing capacity (N)
2700x600x40	0	-
Live load/load bearing capacity		

Connect Shadow + Horizontal

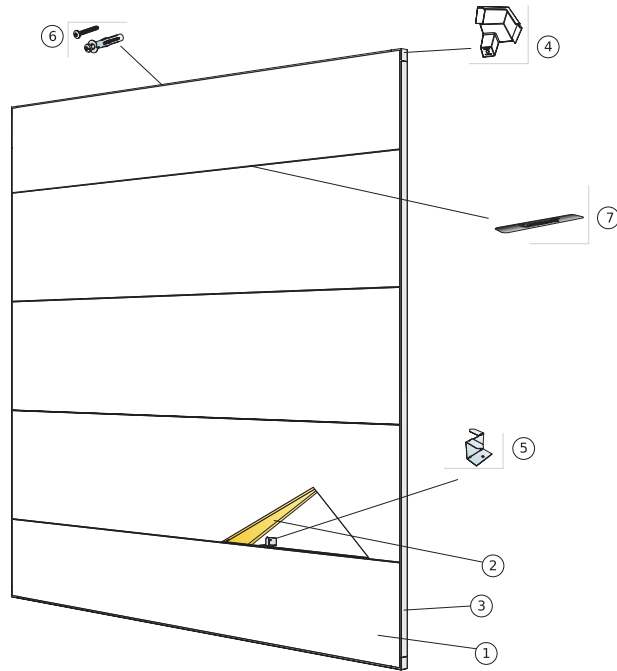

© Ecophon Group

Installation diagram (M547) for Ecophon Akusto Wall Bass horizontal installation with Connect shadow profiles.

Quantity specification (excl. wastage)

	Size, mm
	2700x600
1 Akusto Wall C	0,62/m ²
2 Akusto Extra Bass	1,25/m ²
3 Connect Shadow Profile	as required
4 Connect Shadow Corner (Incl. washer for leveling)	as required
5 Connect Ambient fixing installed at 1000 mm centres	as required
6 Installation screw, installed at 200 mm centres (select fastener according to wall material)	as required
7 Connect Spline	as required
8 Connect Shadow Splice. Used to extend profiles where needed.	as required

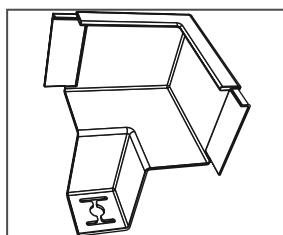
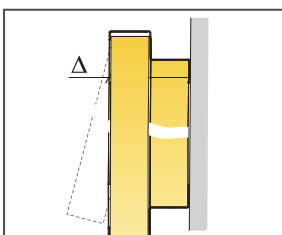

Detail of panel with Thinline frame

Size, mm	Max live load (N)	Min load bearing capacity (N)
2700x600x40	0	-

Live load/load bearing capacity