

# ECOPHON AKUSTO™ WALL EDGE C

Ecophon Akusto Wall C has an angled edge creating a point where the panels meet, ensuring a perfect joint. A captive groove along the panel edge allows the panels to be mechanically secured to the wall without visible hardware. Akusto can be combined with Ecophon's ceilings to create a complete acoustic solution.



# Ecophon Akusto™ Wall Edge C

## SYSTEM RANGE



Size, mm	2700x600
Thinline Profile	•
WP Profile	•
Thickness	40
Inst. Diagr.	M609, M354, M355, M592



Akusto Wall C

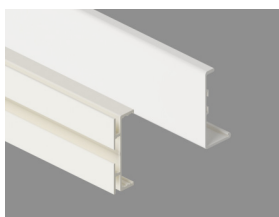

Connect WP profile (Left) & Connect Thinline profile (Right)



Akusto Wall C system with Connect WP profile and external corner



## TYPE OF APPLICATION

- Office
- Education
- Healthcare
- Additional areas



## ACOUSTIC

### Sound Absorption

Test results according to EN ISO 354. Classification according to EN ISO 11654, and the single value ratings for Noise Reduction Coefficient, NRC and Sound Absorption Average, SAA according to ASTM C 423.

$\alpha_p$ , Practical sound absorption coefficient

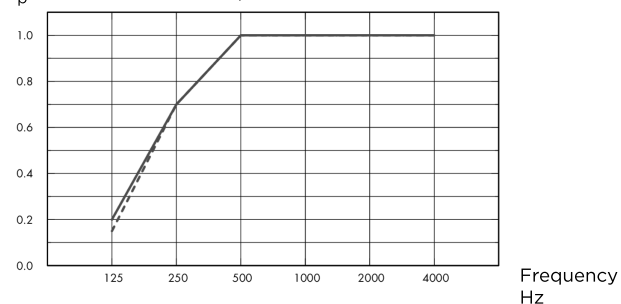

- Akusto Wall C Akutex FT 40 mm, 45 mm o.d.s.
  - Akusto Wall C Texona 40 mm, 45 mm o.d.s.
  - Akusto Wall C Super G 40 mm, 45 mm o.d.s.
- o.d.s = overall depth of system

	THK mm	o.d.s. mm	$\alpha_p$ , Practical sound absorption coefficient						$\alpha_w$	Sound absorption class
			125 Hz	250 Hz	500 Hz	1000 Hz	2000 Hz	4000 Hz		
Akutex FT	40	45	0.20	0.70	1.00	1.00	1.00	1.00	1.00	A
Texona	40	45	0.20	0.70	1.00	1.00	1.00	1.00	1.00	A
Super G	40	45	0.15	0.70	1.00	1.00	1.00	1.00	1.00	A

	THK mm	o.d.s. mm	NRC	SAA
Texona	40	45	0.95	
Super G	40	45	0.95	0.96

THK mm	AC(1.5) Articulation Class, ASTM E1111, ASTM E1110
40	240



## INDOOR AIR QUALITY

Certificate / Label	
Eurofins Indoor Air Comfort®	IAC Gold
French VOC	A+



## CRADLE TO CRADLE CERTIFIED®

Akusto products with Akutex FT surface are Cradle to Cradle Certified® at Bronze level (version 4.0).



## MATERIAL HEALTH

Akusto products with Akutex FT surface have received a C2C Certified Material Health Certificate™ at the Silver level (standard version 4.0). The C2C Certified Material Health Certificate™ is a verification of the health and safety of a product's composition using the Material Health requirements of the Cradle-to-Cradle Certified Product Standard.



## CARBON FOOTPRINT

Life-cycle stages A1 to C4 from EPD, in conformity with ISO 14025 / EN 15804

	kg CO <sub>2</sub> equiv/m <sup>2</sup>
Akusto Wall C - Texona	6,18 (Akusto Wall C EPD in conformity with ISO 14025 / EN 15804)
Akusto Wall C - Akutex FT	6,42 (Akusto Wall C EPD in conformity with ISO 14025 / EN 15804)
Akusto Wall C - Super G	7,28 (Akusto Wall C EPD in conformity with ISO 14025 / EN 15804)



## CIRCULARITY

Minimum post-consumer recycled content	60%
Recyclability	Fully recyclable



## FIRE SAFETY

The glass wool core of the tiles is tested and classified as non-combustible according to EN ISO 1182.

Country	Fire standard	Class
Europe	EN 13501-1	A2-s1,d0



## HUMIDITY RESISTANCE

Class C, relative humidity 95% and 30°C, according to EN 13964:2014



## VISUAL APPEARANCE

Akusto Wall in white has high light reflectance. Light reflectance and nearest NCS colour sample for all the different colours: See Ecophon Colours and surfaces.



## CLEANABILITY

Daily dusting, vacuum cleaning and weekly wet wiping (Super G and Akutex FT surface). Weekly dusting and vacuum cleaning (Texona) as required.



## ACCESSIBILITY

The tiles are not demountable except in selected installation diagrams. See quantity specification for more information.



## INSTALLATION

Installed according to installation diagrams, installation guides and drawing aid. For information regarding minimum overall depth of system see quantity specification. The systems should not be placed behind goals or similar areas where they are likely to be hit regularly. In such cases a protective net in front of the system is recommended.



## PACKAGING INFORMATION

Information is indicative and subject to change.

	Edge	Panels / crt	m <sup>2</sup> / crt
2700x600x40	C	4	6.48



## SYSTEM WEIGHT

Weight information is indicative and subject to variation.

	kg/m <sup>2</sup>
Akusto Wall C/Akutex FT	3,5
Akusto Wall C/Texona	3,5
Akusto Wall C/Super G	3,7



## MECHANICAL PROPERTIES

No additional live load is allowed.



## IMPACT RESISTANCE

Tested and classified to fulfil the requirements of DIN 18032-3, equivalent to 1A according to EN13964..

Surface	M-scratch	Classification
Super G	M354, M609	Fulfills



## CE

Ecophon ceiling systems are CE marked according to the European harmonized standard EN13964:2014. CE marked construction products are covered by a Declaration of Performance (DOP) which enables customers and users to easily compare performance of products available on the European market.

## COLOURS AND DESIGN

### Super G

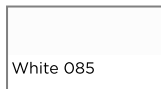

### Akutex™ FT

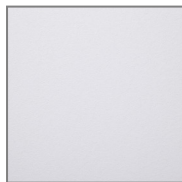

White frost

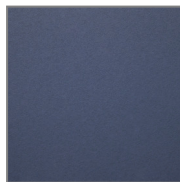

Deep Sea

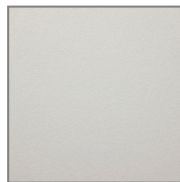

Sage mist

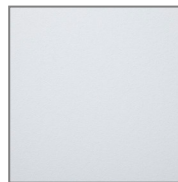

Morning rain



Scallop shells

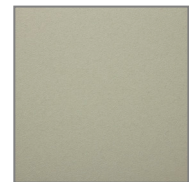

Spring Leaf



Pine Green



Wet sand



Silent steam



Dark diamond



Cloudy day



Volcanic ash



Silver stone

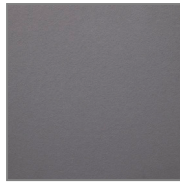

Silk slate

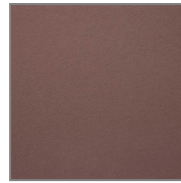

Dark Chestnut

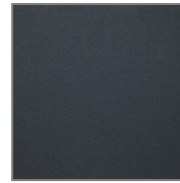

Basalt Rock

### Texona



Winter White



Stone Grey



Silver Lining

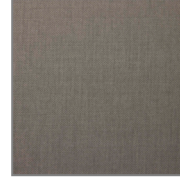

Thunder Grey

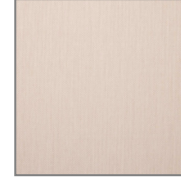

Oat Beige

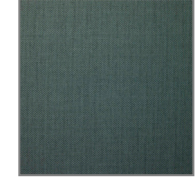

Deep Forest



Linden Green



Midnight Sky



Ice Blue



Autumn Berry



Heathland Rose



Cloudy Pink



Golden Sand

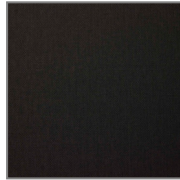

Shadow Black

### Connect WP Colours

Aluminium profile in 'Connect white 03' with textured finish.

Aluminium profile in 'Connect black 01' with textured finish.

Profiles have a natural anodise (colour can vary), corner connectors are similar in colour

Corner Connector with 'Connect white 03' coloured plastic

Corner Connector with 'Connect black 01' coloured plastic

Corner Connector with 'Connect grey 02' coloured plastic

### Connect Thinline Colours

Aluminium profile, external and internal corner connectors in 'Connect white 02'

Aluminium profile, external and internal corner connectors in 'Connect black 01'

Aluminium profile, external and internal corner connectors in 'Connect grey 03'

Aluminium profile and external corner connectors in 'Connect grey 04'

Connect Thinline + Vertical

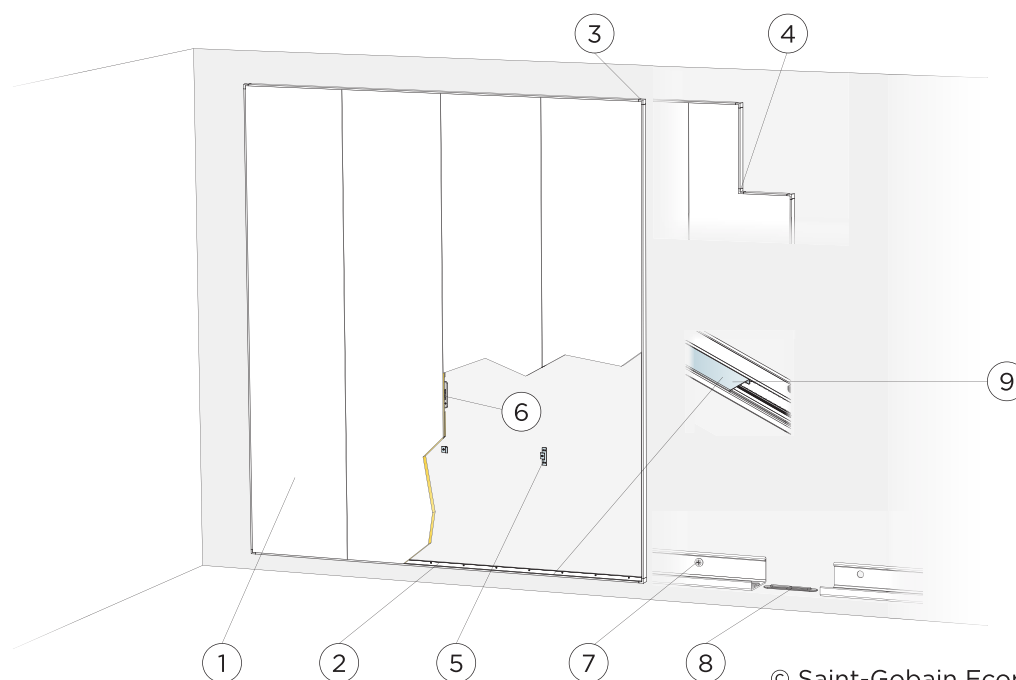

© Saint-Gobain Ecophon AB

Installation diagram (M609) for Ecophon Akusto Wall C vertical installation with Connect Thinline profiles.

Quantity specification (excl. wastage)

		Size, mm
		<b>2700x600</b>
1	Akusto Wall C	0,62/m <sup>2</sup>
2	Connect Thinline Profile, L=2658 mm	as required
3	Connect Thinline Ext. Corner	as required
4	Connect Thinline Int. Corner	as required
5	Connect Fixing Plate installed 3 per panel length	as required
6	Connect Spline	as required
7	Installation screw, (select fastener according to wall material)	as required
8	Connect Thinline Splice. used to extend Thinline profiles where needed.	as required
9	Connect Thinline Space Bar, L=2550 mm	as required
Δ Overall depth of system: 45 mm		

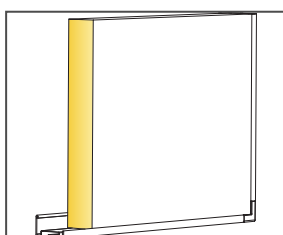
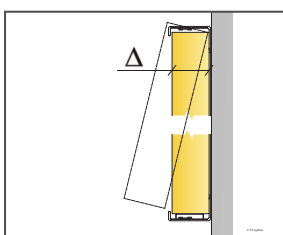

Detail of panel with Thinline frame

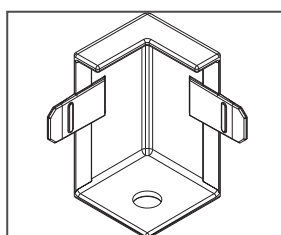

Detail of Thinline corner

Size, mm	Max live load (N)	Min load bearing capacity (N)
2700x600x40	0	-

Live load/load bearing capacity

**Connect WP + Vertical + Impact resistant**

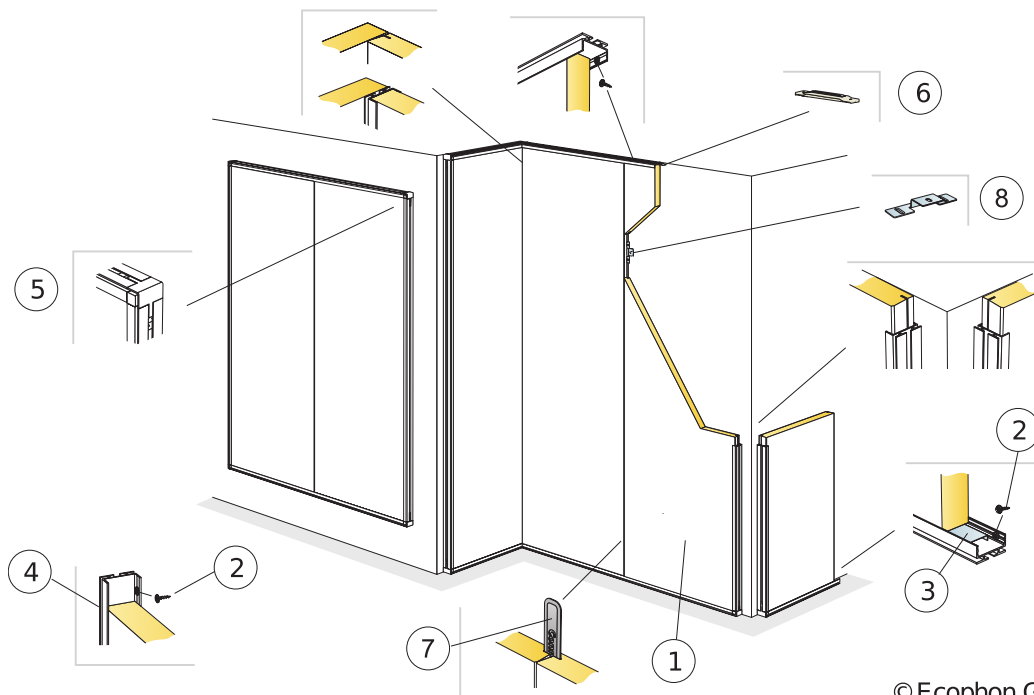

© Ecophon Group

Installation diagram (M354) for Ecophon Akusto Wall C vertical installation

Quantity specification (excl. wastage)

		Size, mm
		<b>2700x600</b>
1	Akusto Wall C (Akusto Wall C/Super G for Ball Impact Resistance)	0,62/m <sup>2</sup>
2	Connect Installation screw MVL (for use in plasterboard or timber)	as required
3	Connect Thinline Space Bar, L=2550 mm	as required
4	Connect WP Profile, L=2687 mm, fixed at 400 mm centres	as required
5	Connect WP External corner mounted in Connect WP Profile	as required
6	Connect WP Profile splice. used to extend WP profiles where needed.	as required
7	Connect Spline	as required
8	Connect Fixing Plate installed 3 per panel length	as required
Δ Min. overall depth of system: 44 mm		

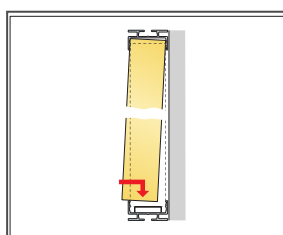
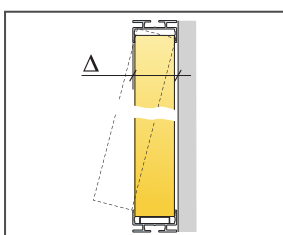

Detail of installation

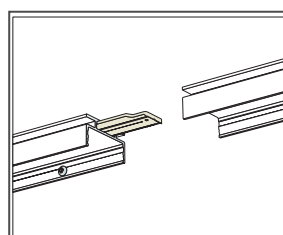

Detail of WP Profile splice

Size, mm	Max live load (N)	Min load bearing capacity (N)
2700x600x40	0	-

Live load/load bearing capacity

Connect WP + Horizontal

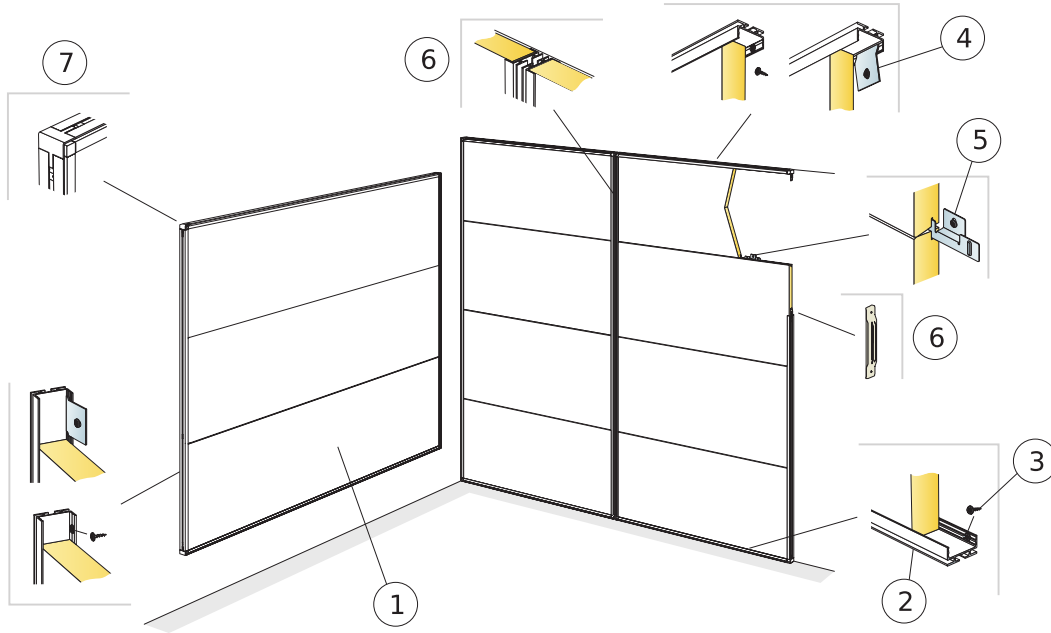

© Ecophon Group

Installation diagram (M355) for Ecophon Akusto Wall C horizontal installation

Quantity specification (excl. wastage)

		Size, mm
		<b>2700x600</b>
1	Akusto Wall C	0,62/m <sup>2</sup>
2	Connect WP Profile, L=2687 mm, fixed at 400 mm centres	as required
3	Connect Installation screw MVL (for use in plasterboard or timber)	as required
4	Alt. Connect Fixing bracket, fixed at 400 mm centres.	as required
5	Connect Fixing Plate installed 3 per panel length	as required
6	Connect WP Profile splice. used to extend WP profiles where needed.	as required
7	Connect WP External corner mounted in Connect WP Profile	as required
Δ Min. overall depth of system: 44 mm		

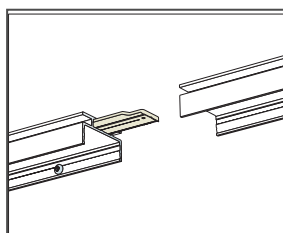
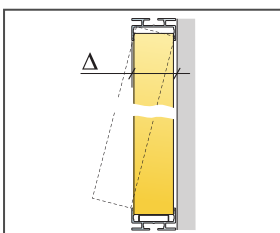

Detail of WP Profile splice

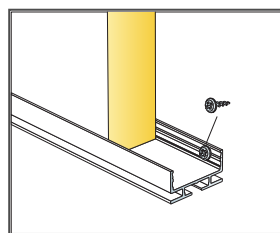

Detail of lower connection

Size, mm	Max live load (N)	Min load bearing capacity (N)
2700x600x40	0	-

Live load/load bearing capacity

Connect Thinline + Horizontal

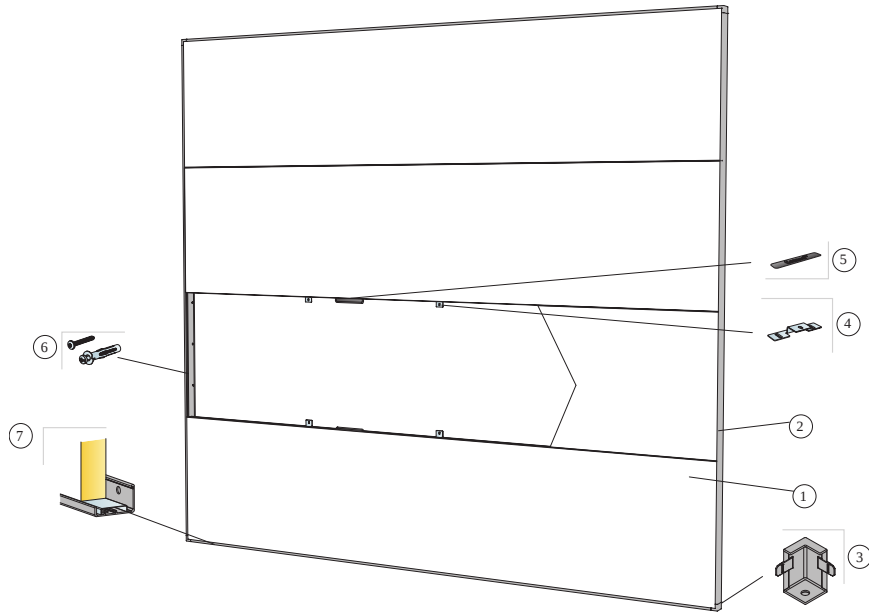

© Ecophon  
Installation diagram (M592) for Ecophon Akusto Wall C horizontal installation with Connect Thinline profiles

Quantity specification (excl. wastage)

	Size, mm
	<b>2700x600</b>
1 Akusto Wall C	0,62/m <sup>2</sup>
2 Connect Thinline Profile, L=2658 mm	as required
3 Connect Thinline Ext. Corner	as required
4 Connect Fixing Plate installed 3 per panel length	as required
5 Connect Spline	as required
6 Installation screw, installed at 400 mm centres (select fastener according to wall material)	as required
7 Connect Thinline Space Bar, L=2550 mm	as required
Δ Overall depth of system: 45 mm	

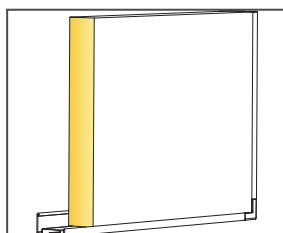
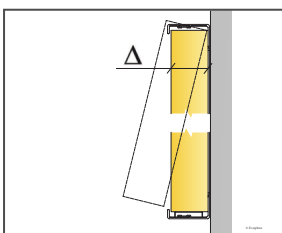

Detail of panel with Thinline frame

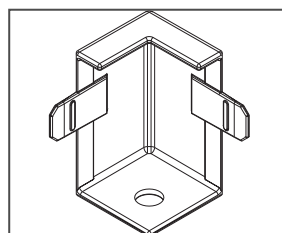

Detail of Thinline corner